

Selection

BASIC
LINE

BASIC
LINEPLUS

VARIO
LINE

TUBE
SERIES

3D
LINE

STEEL
LINE

LS/LSX Series

The power to innovate



LS/LSX Series

Cost-effective steel chains with light design

- Improved dynamic characteristic values due to weight-optimized design
- Long unsupported lengths for small to medium additional loads
- Cover with steel band for protecting the cables is available on request



Optional central bolt for applications with large loads

C-rail for strain relief elements

Strokes are integrated in the chain link plate – no additional bolts are needed

End connectors for different connection variants

Favorable ratio of inner to outer width – no peripheral divider necessary

Weight-optimized chain bands – specially coated or stainless steel

STEEL
SPECIAL COATED

STAINLESS STEEL
RUST-FREE

Different stay variants available in 1 mm width sections

WIDTH SECTIONS
1 mm

Dividers made of plastic or steel

Various cable separation options

Inside height

58

Chain widths

100 - 600

kabelschlepp.de

Font: +49 2762 4003-0

The design

The chains are very light and yet very stable due to the weight-optimized link plate design. The unsupported length for the LS series is significantly higher as compared with plastic chains of the same size.



Weight-optimized link plates only consist of one plate – the stroke system is integrated



Light sidebands without additional bolts – special coating or stainless steel



Optional: Central bolt and locking ring for applications involving large loads



Optional: C-Rail for strain relief elements fixed in the connection

Type LS/LSX 1050

- **Type LS:**
Chain bands made of specially coated steel
- Type LSX:**
High-grade stainless steel chainbands
- **Available in 1 mm width sections**

Inside height
58

Chain widths
100 - 600



Type	h _i	B _k	Maximum travel length ^{A)} in m	Dynamics of unsupported arrangement	
				Travel speed ^{B)} v _{max} in m/s	Travel acceleration a _{max} in m/s ²
LS/LSX 1050	58	100-600	10	5C)	10

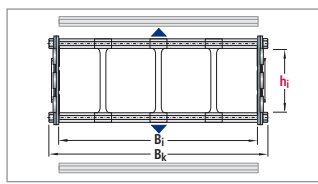

Design guidelines for central bolts and stay arrangement: Dimensions in mm

- Chain length > 4 m:
central bolts **or** stay arrangement on every chain link necessary
- Chain width B_{St} > 400 mm:
central bolts **or** stay arrangement on every chain link necessary
- Travel speed > 2,5 m/s:
Central bolt **or** fully-stayed arrangement necessary
- Use of support rollers:
central bolts **and** stay arrangement on every chain link necessary

The values h_i and B_k are dependent on the stay variant.

A) Values LS versions;
LSX versions see load diagram

B) Values for LSX versions reduced by 0,5 m/s
C) Maximum value

kabelschlepp.de

Bend radius and pitch

Type	Bend radii KR mm								
LS/LSX 1050	105	125	155	195	260	295	325	365	430

Pitch: t = 105 mm

Load diagram

for unsupported length L_f depending on the additional load*

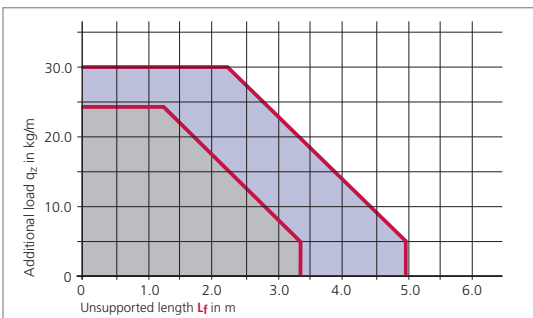

Unsupported length L_f

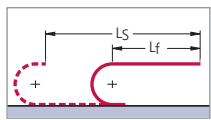

Determining the length of the cable carrier see page 38.

* Load diagram for stay variant RS for medium carrier widths. The possible additional load for large carrier widths and heavy stay variants (e.g. RR) is smaller due to the increased intrinsic chain weight.

- With black special coating
- Material ER 1, ER 1S and LS 1050 with galvanized surface

Example of ordering

Cable carrier	Divider system	Connection
LS 1050 - 180 - RS 2 - 125 - Sb - 2415	TS 0 / 4	FA/MA
Type Stay width B _{St} in mm Stay variant Bend radius KR in mm Chain band material Chain length L _k in mm (without connection)	Divider system Number of dividers n _T	Connection Fixed point/Driver

Chain band materials: Sb = Steel specially coated / ER 1 = Stainless steel / ER 1S = Stainless steel, sea water resistant. Please contact us for further information about the chain band materials.

Ordering divider systems: Please state the designation of the divider system (TS 0, TS 1 ...) and the number of dividers. Possibly attach a sketch with the dimensions.

Fon: +49 2762 4003-0
Use our free project planning service.

Type LS/LSX 1050

Stay variant RS 2 – with bolted stays

- frame stay RS made of aluminium – standard design
- for lightweight to medium loads
- **Standard stay arrangement:** on every 2nd chain link. Stays can be fitted on every chain link, please specify when placing your order.
- bolted stays for maximum stability

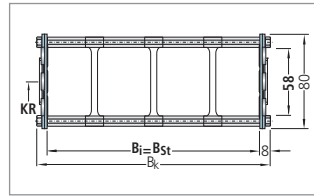

Inside height

58

Chain widths

100 - 600

Dimensions and intrinsic chain weight

Type	Stay variant	h _i	h _G	B _k min	q _k min	B _k max	q _k max	B _i	B _{St}	WIDTH SECTIONS
LS/LSX 1050	RS 2	58	80	100	3.7	400	4.2	B _k - 16	B _{St} = B _i	1 mm

Dimensions in mm/Weights in kg/m

Stay variant RV – frame stay, reinforced design

- frame stay RV made of aluminium – reinforced design
- for medium to heavy loads and for large chain width
- **Standard stay arrangement:** on every 2nd chain link. Stays can be fitted on every chain link, please specify when placing your order.
- bolted stays for maximum stability

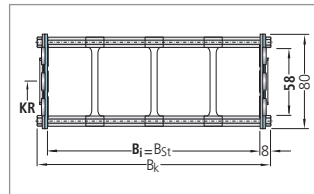
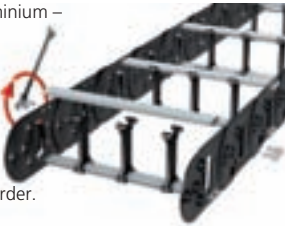

Dimensions and intrinsic chain weight

Type	Stay variant	h _i	h _G	B _k min	q _k min	B _k max	q _k max	B _i	B _{St}	WIDTH SECTIONS
LS/LSX 1050	RV	58	80	100	4.0	600	5.9	B _k - 16	B _{St} = B _i	1 mm

Dimensions in mm/Weights in kg/m

kabelschlepp.de

Font: +49 2762 4003-0

OnlineEngineer.de
KABELSCHLEPP
Cable Chain Configurator

Type LS/LSX 1050

Stay variant RR – frame stay, tube design

Inside height
58

Chain widths
100
600

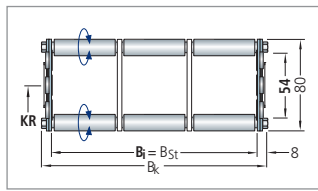
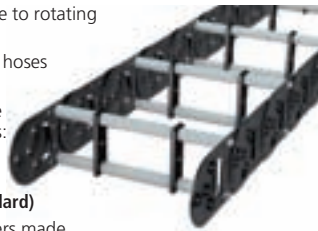

- gentle cable support due to rotating metal tubes
- ideal when using media hoses with "soft" sheaths
- possible materials of the axles, tubes and dividers:
 - axles, tubes and dividers made of galvanized steel (standard)
 - axles, tubes and dividers made of stainless steel ER 1
- Standard stay arrangement:** on every 2nd chain link. Stays can be fitted on every chain link, please specify when placing your order.
- bolted stays for maximum stability

kabelschlepp.de

Dimensions and intrinsic chain weight

Type	Stay variant	h _i	h _G	B _k min	q _k min	B _k max	q _k max	B _i	B _{St}
LS/LSX 1050	RR	54	80	100	4.3	500	8.0	B _k – 16	B _{St} = B _i



Dimensions in mm/Weights in kg/m

Fon: +49 2762 4003-0

Stay variant LG – hole stay made of aluminium, split design

- optimum cable guidance in the neutral bending line is possible
- drilling pattern individually adapted to the application
- high stability due to solid construction
- split design as standard for easy laying of the cables
- Standard stay arrangement:** on every 2nd chain link. Stays can be fitted on every chain link, please specify when placing your order.
- bolted stays for maximum stability – also available not split

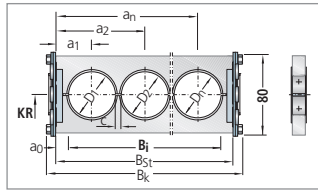
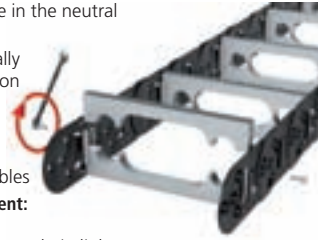

Dimensions and intrinsic chain weight

Type	Stay variant	D max	h _G	B _k min	q _k min*	B _k max	q _k max*	a ₀ min	B _i	B _{St}
LS/LSX 1050	LG	48	80	100	4.1	600	8.1	14	B _{St} – 2 a ₀	B _k – 18



* Listed weights assume that the hole area is approx. 50 % of the stay

Dimensions in mm/Weights in kg/m

See next page for examples of hole patterns.

Type LS/LSX 1050

Examples of hole patterns:

Split hole stay with individual holes

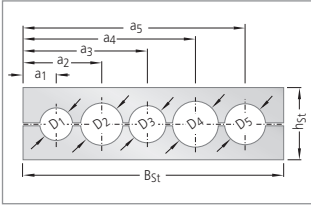

Split hole stay with horizontal and vertical elongated holes*

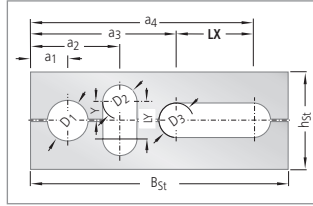

*) With an off-center arrangement of the holes, the cables are subject to a relative movement when the carrier is in motion.

Divider system TS 0 without height subdivision

Type	Stay variant	h _i mm	S _T mm	a _T min mm	a _x min mm
LS/LSX 1050	RS 2	58	4	7	14
LS/LSX 1050	RV	58	4	7	14
LS/LSX 1050	RR	54	4	20	20

The dividers can be moved in the cross section (not for stay variant RR).

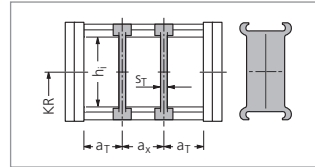

In the standard version, the divider systems are mounted on every second chain link.

Divider system TS 1 with continuous height subdivision made of aluminium

Type	Stay variant	h _i mm	S _T mm	a _T min mm	a _x min mm	S _H mm	h ₁ mm	h ₂ mm
LS/LSX 1050	RS 2	58	4	7	14	4	30	–
LS/LSX 1050	RV	58	4	7	14	4	15	30
LS/LSX 1050	RR	54	4	20	20	8	–	–

The dividers can be moved in the cross section (not for stay variant RR).

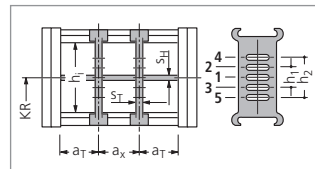

In the standard version, the divider systems are mounted on every second chain link.

Divider system TS 2 with grid subdivision made of aluminium (1 mm grid)

Type	Stay variant	h _i mm	S _T mm	a _T min mm	a _x min mm	S _H mm	h ₁ mm	h ₂ mm
LS/LSX 1050	RS 2	58	4	7	20	4	30	–
LS/LSX 1050	RV	58	6	7	20	4	15	30

The dividers can be moved in the cross section

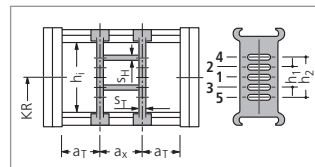

In the standard version, the divider systems are mounted on every second chain link.

Type LS/LSX 1050

Divider system TS 3 with section subdivision, partitions made of plastic

Inside height
58

Type	Stay variant	h _i mm	S _T mm	a _T min mm	a _x min mm	S _H mm	h ₁ mm	h ₂ mm	h ₃ mm
LS/LSX 1050	RV	58	8	4	16*	4	14	28	42

* When using plastic partitions
The dividers are fixed by the partitions, the complete divider system is movable.

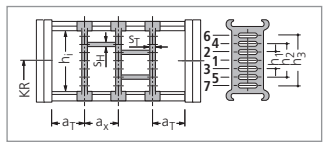

In the standard version, the divider systems are mounted on every second chain link.

Chain widths
100 - 600

Dimensions of the plastic partitions for TS 3

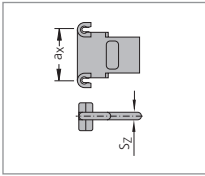

S _z	a _x (center-to-center distance, dividers)									
4	16	18	23	28	32	33	38	43	48	58
	64	68	78	80	88	96	112	128	144	160
	176	192	208	-	-	-	-	-	-	-

Dimensions in mm

When using partitions with a_x > 112 mm, there should be an additional central support with a twin divider (S_T = 4 mm).
Twin dividers are designed for subsequent fitting in the partition system.

kabelschlepp.de

Aluminium partitions in 1 mm width sections are also available.

Strain relief devices

The C-Rails are fixed together with the end connectors and thus do not have to be bolted separately.

Length of the C-Rail L_p:
Fixed point: L_p = B_i
Driver: L_p = B_i + 4 mm



■ C-rail fixed in the end connector.

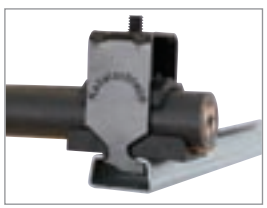

■ Liniflex bracket clamp in C-rail

Fon: +49 2762 4003-0

Integratable C-Rail

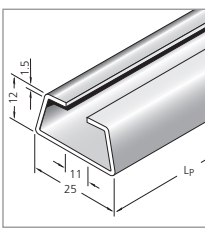

Suitable for all commercially available brackets (slot width 11 mm)
Material Steel
Item-No. 3934
See also Accessories chapter, page 281.



■ Inserting the C-rail in the end connector.



Use our free project planning service.

Guide channels
➤ from page 282



Strain relief devices
➤ from page 288



Cables for cable carrier systems
➤ from page 330



Type LS/LSX 1050

End connectors

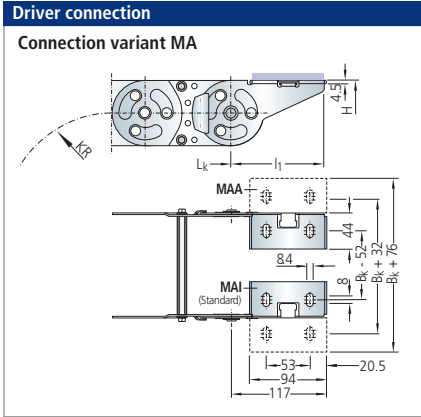
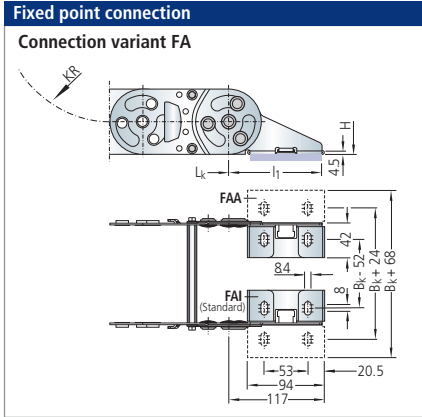

Different connection variants for fixed point and driver are possible according to the drawing information. Different end connectors are needed for different connection variants.

Please state the desired connection variant according to the ordering key.

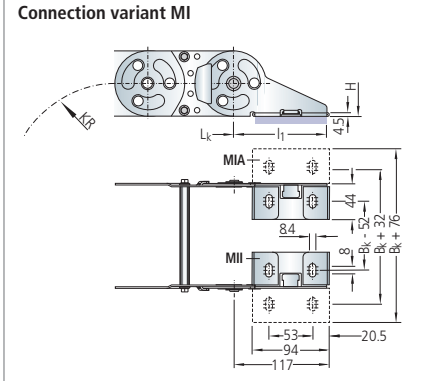

Connection variants

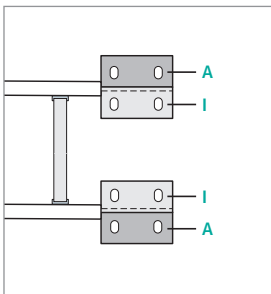
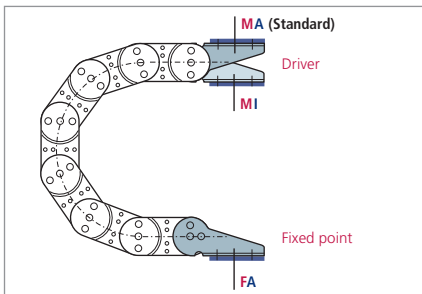

Connection point

- M** – Driver
- F** – Fixed point

Connection type

- A** – Threaded joint outside (standard)
- I** – Threaded joint, inside

Connecting surface

- I** – Connecting surface inside (< Bk)
- A** – Connecting surface outside (> Bk)

Subject to change.

Inside height



Chain widths



kabelschlepp.de

Font: +49 2762 4003-0

OnlineEngineer.de
with Cable Concepts
Cable Center Configurator