

s/sx Series
The power to innovate



S/SX Series

Extremely robust and stable steel chains*

- Extremely robust and stable steel chains for heavy mechanical loads and harsh environmental conditions
- Very long unsupported lengths also for large additional loads
- Various types available in different dimensions
- Covers with aluminium cover system or steel strip possible for protection of the cables

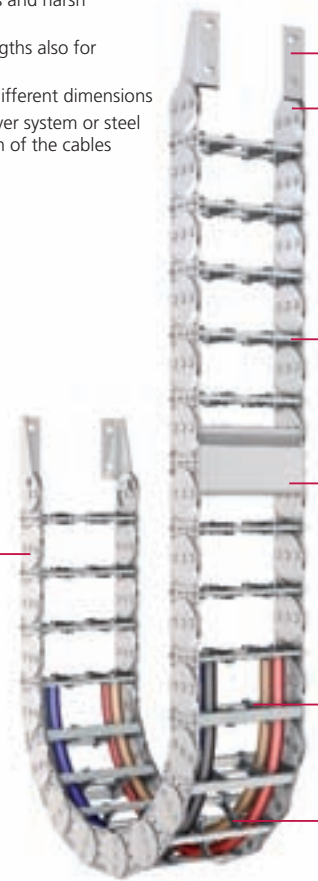

Link design with special bolts for a long service life

The design

Steel cable carriers proven over many years with extremely stable chain link plates and a link design with multiple stroke system and special bolts. Large unsupported lengths and high additional loads are possible due to the extremely stable design.

- End connectors for different connection variants
- Extremely robust chain bands galvanized or made of stainless steel

STEEL
GALVANIZED
STAINLESS STEEL
RUST-FREE

- Different stay variants available in 1 mm width sections



- Aluminium cover available in 1 mm width sections



- Dividers made of plastic or steel

- Various cable separation options



Sandwich design: Chain link plates consist of two plates welded together



Glide shoes for gliding applications are available



Stroke system with special bolts and locking rings



Also available as covered variants with cover system or steel band covering

Inside heights



Chain widths



kabelschlepp.de

Fon: +49 2762 4003-0

OnlineEngineer.de
KABELSCHLEPP
Cable Carrier Configurator

* Some features can be different for certain types for design reasons. Our specialists are happy to advise you.

S/SX Series

Selection

BASIC LINE

BASIC LINEPLUS

VARIO LINE

TUBE SERIES

3D LINE

STEEL LINE

Overview S/SX Series

Types S/SX 0650, 0950, 1250, 1800

Inside heights



Chain widths



- Available in 1 mm width sections

WIDTH SECTIONS

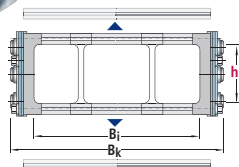
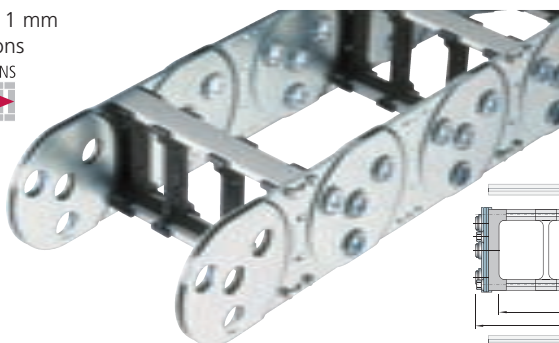

Type	h_i	B_k	Maximum travel length unsupported arrangement ^{A)} in m	Dynamics of unsupported arrangement		Page
				Travel speed ^{B)} v_{max} in m/s	Travel acceleration a_{max} in m/s ²	
S/SX 0650	31	70-500	6	2.5	5.0	254
S/SX 0950	46	125-600	9	2.5	5.0	254
S/SX 1250	72	130-800	12	2.5	5.0	254
S/SX 1800	108	180-1000	18	2.0	3.0	254

A) Values S versions; SX versions see load diagram of the respective type

B) Values for SX versions reduced by 0.5 m/s

The values h_i and B_k are dependent on the stay variant.

Dimensions in mm

Fon: +49 2762 4003-0

STEEL TUBES – Types S/SX 0650 – 1800

- Aluminium cover system
- Available in 1 mm width sections

WIDTH SECTIONS

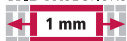

Detailed information for the stay variant RMD can be found on page 257.

Use our free project planning service.

Overview S/SX Series

Types S/SX 2500 and 3200

- Available in 1 mm width sections

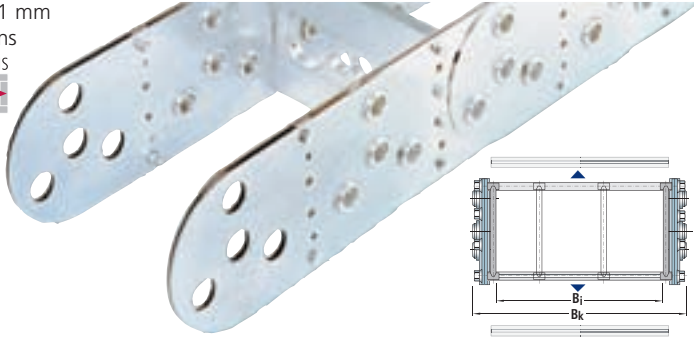

Inside heights



Chain widths



Type	h_i	B_k	Maximum travel length unsupported arrangement ^{A)} in m	Dynamics of unsupported arrangement		Page
				Travel speed ^{B)} v_{max} in m/s	Travel acceleration a_{max} in m/s ²	
S/SX 2500	183	250-1200	24	2.0	3.0	262
S/SX 3200	220	250-1500	25	2.0	2.5	262

A) Values S versions; SX versions see load diagram of the respective type

B) Values for SX versions reduced by 0.5 m/s

Dimensions in mm

The values h_i and B_k are dependent on the stay variant.

Types S/SX 5000 to 7000

- Available in 1 mm width sections



For applications with extremely large additional loads and very large carrier dimensions. Cable and hose carriers of the types 5000 / 6000 / 7000 are usually special designs for special applications such as in the offshore area for example

Type	h_i	B_k	Maximum travel length unsupported arrangement ^{A)} in m	Dynamics of unsupported arrangement		Page
				Travel speed ^{B)} v_{max} in m/s	Travel acceleration a_{max} in m/s ²	
S/SX 5000	150	150-1000	12	2.0	3.0	266
S/SX 6000	240	200-1200	18	1.5	2.0	266
S/SX 7000	370	350-1800	25	1.0	1.0	266

A) Values S versions; SX versions see load diagram of the respective type

B) Values for SX versions reduced by 0.5 m/s

kabelschlepp.de

Font: +49 2762 4003-0

OnlineEngineer.de
KABELSCHLEPP
Cable Carrier Configurator

Types S/SX 0650, 0950, 1250, 1800

- **Type S:**
Chainbands made of galvanized steel
- **Type SX:**
Chainbands made of high-grade stainless steel
- **Available in 1 mm width sections**



Inside heights



Chain widths



Bend radius and pitch

Type	Bend radii KR mm												
S/SX 0650	75	95	115	125	135	145	155	175	200	250	300	400	–
S/SX 0950	125	140	170	200	260	290	320	350	410	600	–	–	–
S/SX 1250	145	200	220	260	300	340	380	420	460	500	540	600	1000
S/SX 1800	265	320	375	435	490	605	720	890	1175	1405	–	–	–

Pitch:
 S/SX 0650: t = 65 mm
 S/SX 0950: t = 95 mm
 S/SX 1250: t = 125 mm
 S/SX 1800: t = 180 mm

Intermediate radii upon request.

kabelschlepp.de

Load diagrams

for unsupported length L_f depending on the additional load*

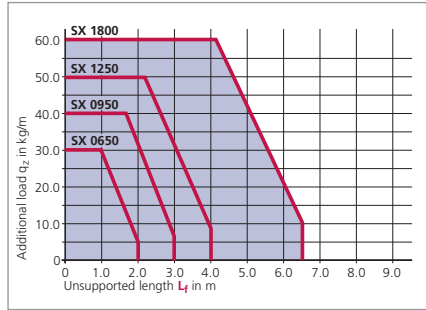
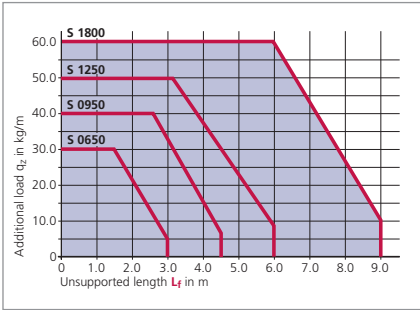

Fon: +49 2762 4003-0

Unsupported length L_f

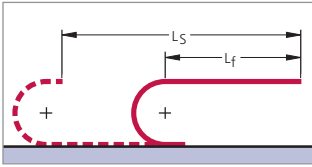

Determining the length of the cable carrier see page 38.

* Load diagram for stay variant RV for medium carrier widths. The possible additional load for large carrier widths and heavy stay variants (e.g. RMD) is smaller due to the increased intrinsic chain weight.

Example of ordering

Cable carrier						Divider system		Connection
S 0950	300	RS 1	200	St	2375	TS 0	4	FA/MA
Type	Stay width B_{st} in mm	Stay variant	Bend radius KR in mm	Chain band material	Chain length L_k in mm (with-out connection)	Divider system	Number of dividers n_T	Connection Fixed point/Driver

Chain band materials: St = Galvanized steel / ER 1 = Stainless steel / ER 1S = Stainless steel, sea water resistant / ER 2 = High-strength stainless steel. Please contact us for further information about the chain band materials.

Ordering divider systems: Please state the designation of the divider system (TS 0, TS 1 ...) and the number of dividers. Possibly attach a sketch with the dimensions.

Use our free project planning service.

Type S/SX 0650, 0950, 1250, 1800

Stay variant RS 2 – with bolted stays

- frame stay RS made of aluminium – standard design
- for lightweight to medium loads
- **Standard stay arrangement:** on every 2nd chain link. Stays can be fitted on every chain link, please specify when placing your order.
- bolted stays for maximum stability

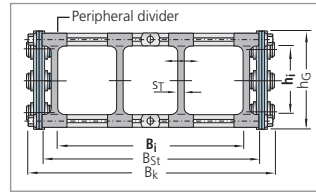
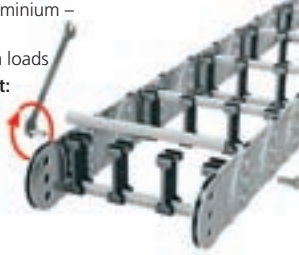

Inside heights

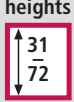

Chain widths



Dimensions and intrinsic chain weight

Type	Stay variant	h _i	h _G	B _k min	q _k min	B _k max	q _k max	B _i	B _{St}	WIDTHSECTIONS
S/SX 0650	RS 2	31	50	100	3.9	400	5.2	B _k – 31	B _i + 16	
S/SX 0950	RS 2	46	68	150	7.5	400	8.2	B _k – 37	B _i + 18	
S/SX 1250	RS 2	72	94	200	12.9	500	13.7	B _k – 44	B _i + 20	

Dimensions in mm/Weights in kg/m

Stay variant RS 1 – with a detachable stay

- frame stay RS made of aluminium – solid design
- for lightweight to medium loads
- **Standard opening options:**
Outside: The cable carrier can be opened quickly and easily simply by rotating the stays through 90°. **Inside:** Screwed stays
Optional: Bolted on the outside and opening inwards, please state when ordering.
- **Standard stay arrangement:** on every 2nd chain link. Stays can be fitted on every chain link, please specify when placing your order.

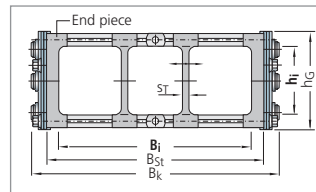
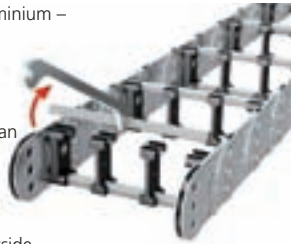

Dimensions and intrinsic chain weight

Type	Stay variant	h _i	h _G	B _k min	q _k min	B _k max	q _k max	B _i	B _{St}	WIDTHSECTIONS
S/SX 0650	RS 1	31	50	100	3.9	300	4.8	B _k – 35	B _i + 20	
S/SX 0950	RS 1	46	68	150	7.5	300	8.0	B _k – 43	B _i + 24	
S/SX 1250	RS 1	72	94	200	12.9	400	13.5	B _k – 48	B _i + 24	

Dimensions in mm/Weights in kg/m

The illustrations on this page show the design principle. The design of individual types can be different.

Types S/SX 0650, 0950, 1250, 1800

Stay variant RV – frame stay, reinforced design

- frame stay RV made of aluminium – reinforced design
- for medium to heavy loads and for large chain width
- **Standard stay arrangement:** on every 2nd chain link. Stays can be fitted on every chain link, please specify when placing your order.
- bolted stays for maximum stability

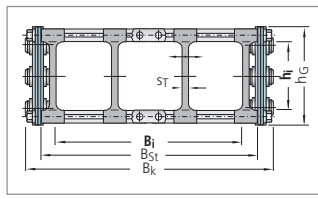
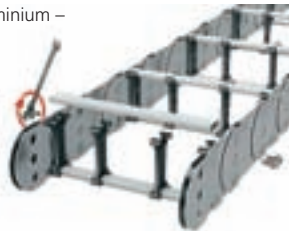

Inside heights
43
108

Chain widths
125
1000

Dimensions and intrinsic chain weight

Type	Stay variant	hi	hG	Bk min	qk min	Bk max	qk max	Bi	BSt
S/SX 1250	RV	72	94	200	13.6	600	17.0	Bk – 46	Bi + 22



Dimensions in mm/Weights in kg/m

kabelschlepp.de

Fon: +49 2762 4003-0

Stay variant RM – frame stay, solid design

- frame stay RM made of aluminium – solid design
- for heavy loads – maximum chain widths possible
- **Standard stay arrangement:** on every 2nd chain link. Stays can be fitted on every chain link, please specify when placing your order.
- bolted stays for maximum stability

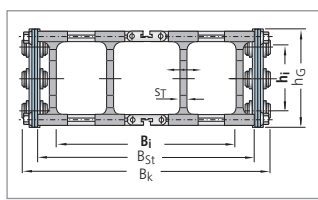
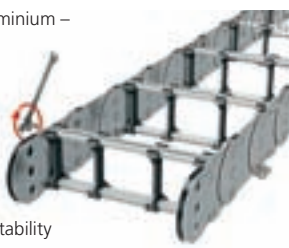

Dimensions and intrinsic chain weight

Type	Stay variant	hi	hG	Bk min	qk min	Bk max	qk max	Bi	BSt
S/SX 0950	RM	43	68	125	7.9	600	10.7	Bk – 37	Bi + 18
S/SX 1250	RM	69	94	200	13.4	800	17.0	Bk – 49	Bi + 25
S/SX 1800	RM	108	140	250	24.0	1000	28.5	Bk – 62	Bi + 33



Dimensions in mm/Weights in kg/m

Use our free project planning service.

Types S/SX 0650, 0950, 1250, 1800

Stay variant RR – frame stay, tube design

- gentle cable support due to rotating metal tubes
- ideal when using media hoses with "soft" sheaths
- possible materials of the axles, tubes and dividers:
 - axles and tubes, galvanized steel with plastic dividers (**Standard**)
 - axles, tubes and dividers made of galvanized steel
 - axles, tubes and dividers made of stainless steel ER 1, ER 1S
- Standard stay arrangement:** on every 2nd chain link. Stays can be fitted on every chain link, please specify when placing your order.
- bolted stays for maximum stability

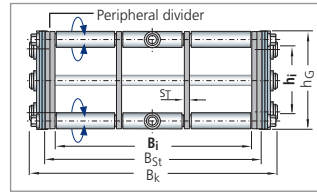
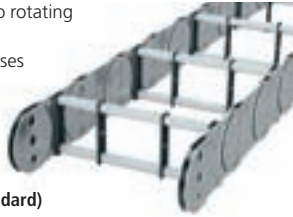

Inside heights

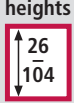

Chain widths



Dimensions and intrinsic chain weight

Type	Stay variant	h_i	h_G	B_k min	q_k min	B_k max	q_k max	B_i	B_{St}
S/SX 0650	RR	26	50	100	4.8	400	8.7	$B_k - 31$	$B_i + 16$
S/SX 0950	RR	42	68	150	8.4	500	11.8	$B_k - 35$	$B_i + 16$
S/SX 1250	RR	66	94	200	13.8	600	17.3	$B_k - 40$	$B_i + 16$
S/SX 1800	RR	104	140	250	26.5	800	36.0	$B_k - 49$	$B_i + 20$

Dimensions in mm/Weights in kg/m

Stay variant RMD – covered cable carrier, STEEL TUBE

- aluminium cover system for protecting the cables and hoses
- for applications where chips or severe contamination occur
- bolted aluminium cover for maximum stability

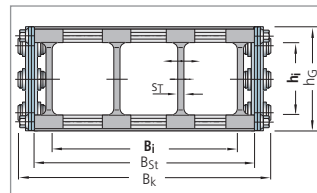
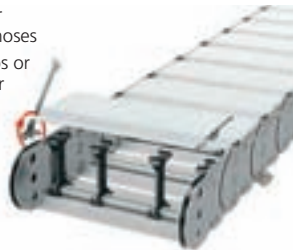

Steel band covers are also available as light-weight, economically priced alternatives to covering with the aluminium cover system, see page 268.



Dimensions and intrinsic chain weight

Type	Stay variant	h_i	h_G	B_k min	q_k min	B_k max	q_k max	B_i	B_{St}	KR_{min}
S/SX 0650	RMD	30	50	100	4.8	500	10.5	$B_k - 35$	$B_i + 20$	115
S/SX 0950	RMD	44	68	125	10.2	600	22.0	$B_k - 37$	$B_i + 18$	170
S/SX 1250	RMD	69	94	150	15.4	800	32.4	$B_k - 49$	$B_i + 25$	200
S/SX 1800	RMD	104	140	250	26.5	1000	46.5	$B_k - 62$	$B_i + 33$	320

Dimensions in mm/Weights in kg/m

WIDTHSECTIONS



kabelschlepp.de

Font: +49 2762 4003-0

OnlineEngineer.de
with KABELSCHLEPP
Cable Carrier Configurator

Inside heights



Chain widths



kabelschlepp.de

Fon: +49 2762 4003-0

Use our free project planning service.

Types S/SX 0650, 0950, 1250, 1800

Stay variant LG – hole stay made of aluminium, split design

- optimum cable guidance in the neutral bending line is possible
- drilling pattern individually adapted to the application
- high stability due to solid construction
- split design as standard for easy laying of the cables
- **Standard stay arrangement:** on every 2nd chain link. Stays can be fitted on every chain link, please specify when placing your order.
- bolted stays for maximum stability – also available not split

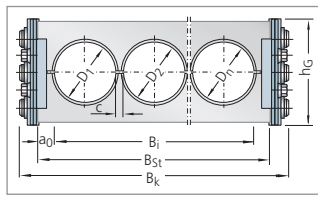
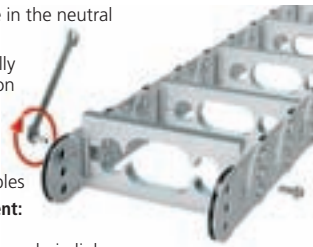

Dimensions and intrinsic chain weight

Type	Stay variant	D max	hG	Bk min	qk min*	Bk max	qk max*	a0 min	B1	BSt
S/SX 0650	LG	40	50	70	4.0	500	6.4	9.0	BSt – 18	Bk – 17
S/SX 0950	LG	48	68	125	8.1	600	11.8	11.0	BSt – 22	Bk – 21
S/SX 1250	LG	74	94	130	13.2	800	18.2	11.0	BSt – 22	Bk – 26
S/SX 1800	LG	110	140	180	24.8	1000	33.0	13.5	BSt – 27	Bk – 32



* Listed weights assume that the hole area is approx. 50 % of the stay.

Dimensions in mm/Weights in kg/m

Selection of some hole patterns:

Split hole stay with individual holes

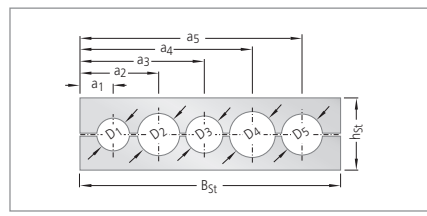

Split hole stay with horizontal and vertical elongated holes*

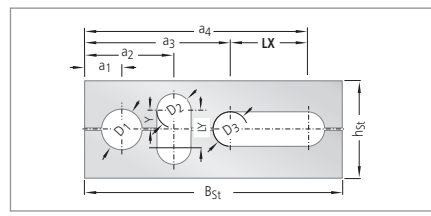

*) With an off-center arrangement of the holes, the cables are subject to a relative movement when the carrier is in motion.

Stay variant LG with the modular hole stay system



Modular hole stay system – split design

The plastic modular hole stay system enables you to create your own customized hole stay quickly and easily. Hole stay inserts are available for Series S 1250 and SX 1250. Available hole diameters: 10, 15, 20, 25, 30, 40, 50. Please do get in touch with us, we would be happy to advise you.

Types S/SX 0650, 0950, 1250, 1800

Divider system TS 0 without height subdivision

Type	Stay variant	h _i mm	S _T mm	a _T min mm	a _x min mm
S/SX 0650	RS 1/2	31	3	11.5	13
S/SX 0650	RMD	30	3	11.5	13
S/SX 0650	RR	26	4	20.0	25
S/SX 0950	RS 1/2	46	4	12.0	14
S/SX 0950	RM	43	4	10.0	14
S/SX 0950	RMD	44	4	12.0	14
S/SX 0950	RR	42	4	20.0	20
S/SX 1250	RS 1/2	72	5	12.5	15
S/SX 1250	RV	72	6	13.0	16
S/SX 1250	RM	69	5	17.5	20
S/SX 1250	RMD	69	5	17.5	20
S/SX 1250	RR	66	4	30.0	30
S/SX 1800	RM	108	7.5	21.5	25
S/SX 1800	RMD	104	7.5	21.5	25
S/SX 1800	RR	104	5	45.0	45

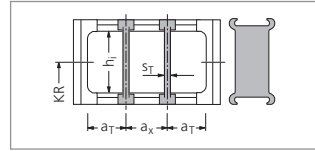

In the standard version, the divider systems are mounted on every second chain link.

The dividers can be moved in the cross section.

S/SX Series

Selection

BASIC LINE

BASIC LINE PLUS

VARIO LINE

TUBE SERIES

3D LINE

STEEL LINE

Inside heights

31
108

Chain widths

70
1000

kabelschlepp.de

Divider system TS 1 with continuous height subdivision made of aluminium

Type	Stay variant	h _i mm	S _T mm	a _T min mm	a _x min mm	S _H mm	h ₁ mm	h ₂ mm	h ₃ mm
S/SX 1250	RV	72	6	13	16	4	15	30	45

The dividers can be moved in the cross section.

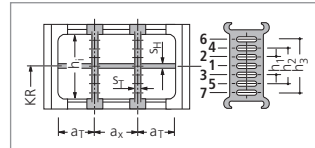

In the standard version, the divider systems are mounted on every second chain link.

Fon: +49 2762 4003-0

Divider system TS 2 with grid subdivision made of aluminium (1 mm grid)

Type	Stay variant	h _i mm	S _T mm	a _T min mm	a _x min mm	S _H mm	h ₁ mm	h ₂ mm	h ₃ mm
S/SX 1250	RV	72	6	13	20	4	15	30	45

The dividers can be moved in the cross section.

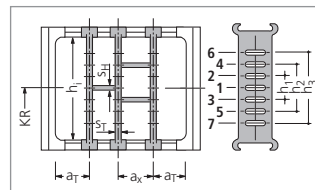

In the standard version, the divider systems are mounted on every second chain link.

OnlineEngineer.de
KABELSCHLEPP
Cable Center Configurator

Types S/SX 0650, 0950, 1250, 1800

Divider system TS 3 with section subdivision, partitions made of plastic

Inside heights



Chain widths



Type	Stay variant	h _i mm	S _T mm	a _T min mm	a _x min mm	S _H mm	h ₁ mm	h ₂ mm	h ₃ mm	h ₄ mm	h ₅ mm
S/SX 1800	RM	108	8	11.5	16*	4	14	28	42	56	70

* When using plastic partitions
The dividers are fixed by the partitions, the complete divider system is movable.

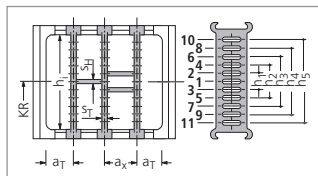

In the standard version, the divider systems are mounted on every second chain link.

Dimensions of the plastic partitions for TS 3

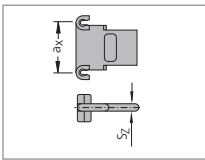

S _z	a _x (center-to-center distance, dividers)									
4	16	18	23	28	32	33	38	43	48	58
	64	68	78	80	88	96	112	128	144	160
	176	192	208	-	-	-	-	-	-	-

Dimensions in mm

Aluminium partitions in 1 mm width sections are also available.

When using partitions with a_x > 112 mm, there should be an additional central support with a twin divider (S_T = 4 mm).
Twin dividers are designed for subsequent fitting in the partition system.

kabelschlepp.de

Fon: +49 2762 4003-0

Use our free project planning service.

Guide channels
➤ from page 282



Strain relief devices
➤ from page 288



Cables for cable carrier systems
➤ from page 330



Types S/SX 0650, 0950, 1250, 1800

End connectors made of steel (types S) or high-grade steel (types SX)

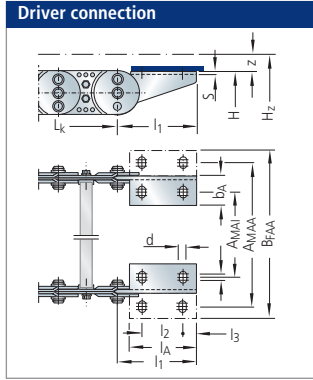
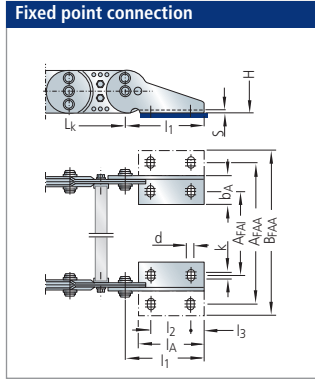

Inside heights



Chain widths

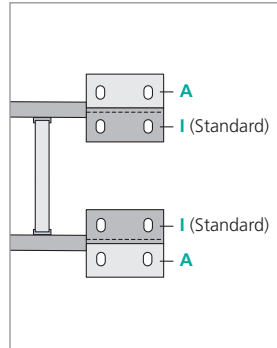
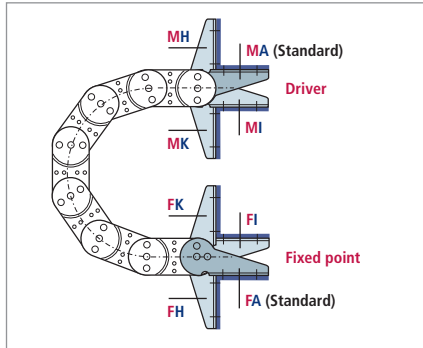

Table of dimensions:

Type	l_1	l_2	l_3	l_A	b_A	d	k	s	A_{FAI}	A_{FAA}	B_{FAA}	A_{MAI}	A_{MAA}	B_{MAA}
S/SX 0650	95	45	15	75	30	6.4	5	3	B _k -37	B _k +25	B _k +51	B _k -43	B _k +19	B _k +45
S/SX 0950	125	65	20	105	55	8.4	10	4	B _k -63	B _k +49	B _k +99	B _k -71	B _k +41	B _k +91
S/SX 1250	155	80	25	130	55	10.5	10	5	B _k -64	B _k +46	B _k +96	B _k -74	B _k +36	B _k +86
S/SX 1800	210	115	30	175	60	13	10	5	B _k -77	B _k +53	B _k +103	B _k -88	B _k +41	B _k +91

Dimensions in mm

Connection variants



Connection point

- M** – Driver
- F** – Fixed point

Connection type

- A** – Threaded joint outside (standard)
- I** – Threaded joint, inside
- H** – Threaded joint, rotated through 90° to the outside
- K** – Threaded joint, rotated through 90° to the inside

Connecting surface

- I** – Connecting surface inside (< B_k)
- A** – Connecting surface outside (> B_k)

On the driver and the fixed point, the connecting surfaces can be mounted on the outside or the inside according to preference.

The connection type can easily be altered at a later date.

In the standard version, the connectors are mounted with the bolting to the outside and the connecting surface to the inside (FAI/MAI). When ordering please specify the desired connection type.

Types S/SX 2500 and 3200

- **Type S:**
Chainbands made of galvanized steel
- **Type SX:**
Chainbands made of high-grade stainless steel
- **Available in 1 mm width sections**

Inside heights



Chain widths



WIDTH SECTIONS

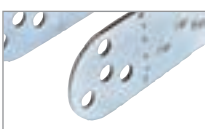

Side plate construction for types S/SX 2500

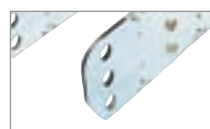

Side plate construction for types S/SX 3200

Bend radius and pitch

Type	Bend radii KR mm							
S/SX 2500	365	445	600	760	920	1075	1235	1395
S/SX 3200	-	470	670	870	1075	1275	1480	1785

Pitch:
S/SX 2500: t = 250 mm
S/SX 3200: t = 320 mm

Load diagrams

for unsupported length L_f depending on the additional load*

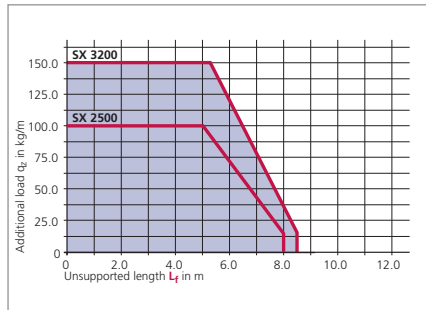
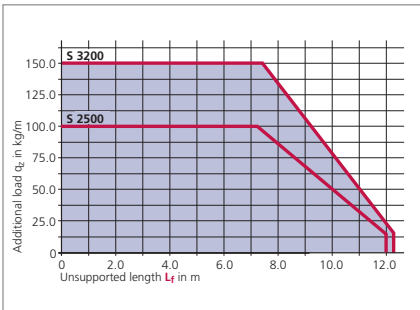

Unsupported length L_f

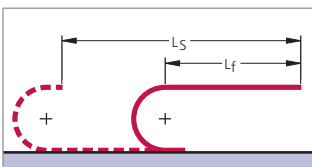

Determining the length of the cable carrier see page 38.

* Load diagrams for medium intrinsic chain weight. The possible additional load for large carrier widths is smaller due to the increased intrinsic chain weight.

Example of ordering

Cable carrier
S 2500 - **850** - **LG** - **760** - **ER 1** - **9250**
 Type Stay width B_{st} in mm Stay variant Bend radius KR in mm Chain band material Chain length L_k in mm (with-out connection)

Divider system
TS 0 / **4**
 Divider system Number of dividers n_T

Connection
FA/MA
 Connection Fixed point/Driver

Chain band materials: St = Galvanized steel / ER 1 = Stainless steel / ER 1S = Stainless steel, sea water resistant / ER 2 = High-strength stainless steel. Please contact us for further information about the chain band materials.

Ordering divider systems: Please state the designation of the divider system (TS 0, TS 1 ...) and the number of dividers. Possibly attach a sketch with the dimensions.

kabelschlepp.de

Fon: +49 2762 4003-0

Use our free project planning service.

Type S/SX 2500

Stay variant RM – frame stay, solid design

- frame stay RM made of aluminium – solid design
- for heavy loads – maximum chain widths possible
- **Standard stay arrangement:** on every 2nd chain link. Stays can be fitted on every chain link, please specify when placing your order.
- bolted stays for maximum stability

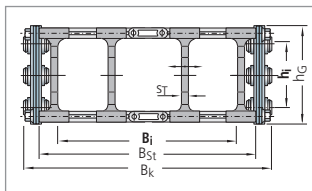
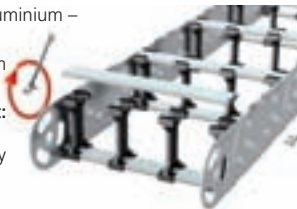

Inside height

183

Chain widths

250 - 1200

Dimensions and intrinsic chain weight

Type	Stay variant	h _i	h _G	B _k min	q _k min	B _k max	q _k max	B _j	B _{St}	WIDTHSECTIONS
S/SX 2500	RM	183	220	250	39	1200	44	B _k – 75	B _j + 43	1 mm

Dimensions in mm/Weights in kg/m

kabelschlepp.de

Standard divider for different separation options

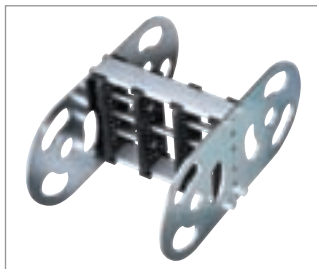

Dividers are available for stay variant RM which enable different height subdivisions of the steel tube to be achieved.

Please do get in touch with us. We would be happy to advise you.

Font: +49 2762 4003-0

OnlineEngineer.de
With Cable Carrier
Cable Carrier Configurator

Guide channels
➤ from page 282

Strain relief devices
➤ from page 288

Cables for cable carrier systems
➤ from page 330

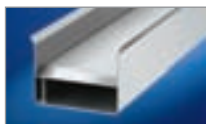

Types S/SX 2500 and 3200

Stay variant LG – hole stay made of aluminium, split design

Inside height
180
220

Chain widths
250
1500

- optimum cable guidance in the neutral bending line is possible
- drilling pattern individually adapted to the application
- high stability due to solid construction
- split design as standard for easy laying of the cables
- **Standard stay arrangement:** on every 2nd chain link. Stays can be fitted on every chain link, please specify when placing your order.
- bolted stays for maximum stability – also available not split

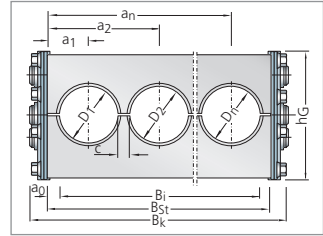
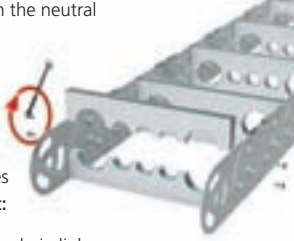

Dimensions and intrinsic chain weight

Type	Stay variant	D max	hG	B _k min	q _k min*	B _k max	q _k max*	a ₀ min	B _i	B _{St}
S/SX 2500	LG	180	220	250	36.5	1200	48.5	22	B _{St} - 44	B _k - 32
S/SX 3200	LG	220	300	250	57.5	1500	72.5	22	B _{St} - 44	B _k - 40



* Listed weights assume that the hole area is approx. 50 % of the stay.

Dimensions in mm/Weights in kg/m

kabelschlepp.de

Fon: +49 2762 4003-0

Selection of some hole patterns:

Split hole stay with individual holes

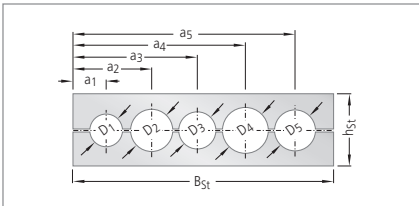

Split hole stay with horizontal and vertical elongated holes*

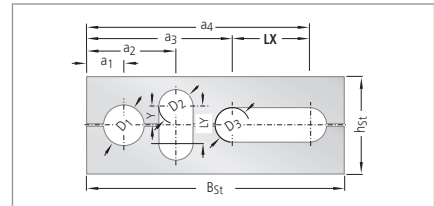

*) With an off-center arrangement of the holes, the cables are subject to a relative movement when the carrier is in motion.

Use our free project planning service.

Guide channels
➤ from page 282

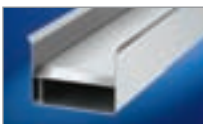

Strain relief devices
➤ from page 288



Cables for cable carrier systems
➤ from page 330



Types S/SX 2500 and 3200

End connectors made of steel (types S) or high-grade steel (types SX)

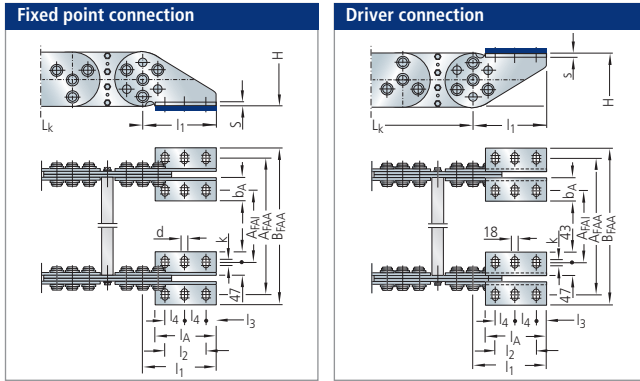
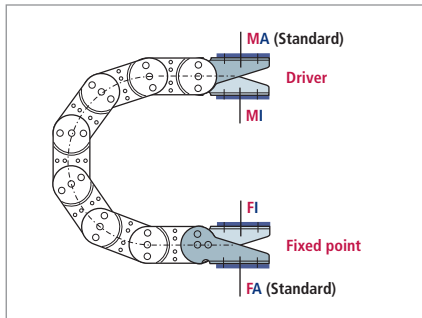

Table of dimensions:

Type	l_1	l_2	l_3	l_4	l_A	b_A	d	k	s	A_{FAI}	A_{FAA}	B_{FAA}	A_{MAI}	A_{MAA}	B_{MAA}
S/SX 2500	300	170	40	85	250	90	18	15	6	B_k-126	B_k+74	B_k+160	B_k-126	B_k+74	B_k+160
S/SX 3200	350	200	50	100	300	110	22	20	6	B_k-154	B_k+90	B_k+196	B_k-154	B_k+90	B_k+196

Dimensions in mm

Connection variants



Connection point

- M** – Driver
- F** – Fixed point

Connection type

- A** – Threaded joint outside (standard)
- I** – Threaded joint, inside

In the standard version, the end connectors are mounted with the threaded joint outwards (MA/FA). When ordering please specify the desired connection type (see ordering key on page 326).

Inside height

180
220

Chain widths

250
1500

Types S/SX 5000, 6000, 7000

- Type S:
Chainbands made of galvanized steel
- Type SX:
Chainbands made of high-grade stainless steel

- Available in 1 mm width sections



Inside heights



Chain widths



Dimensions and intrinsic chain weight

Type	h_i max	h_G	B_k min	B_k max
S/SX 5000	150	200	250	1200
S/SX 6000	240	300	300	1500
S/SX 7000	370	450	350	1800

Larger dimensions and special designs are available on request.

Dimensions in mm

Bend radius and pitch

Type	Bend radii KR mm				
S/SX 5000	500	600	800	1000	1200
S/SX 6000	700	900	1100	1300	1500
S/SX 7000	1100	1250	1500	1800	2400

Pitch:

S/SX 5000: $t = 200$ mm

S/SX 6000: $t = 320$ mm

S/SX 7000: $t = 450$ mm



Types S/SX 5000, 6000, 7000

Load diagram

for unsupported length L_f depending on the additional load

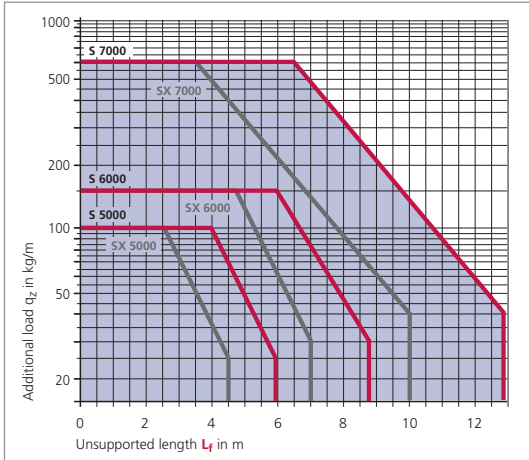

Unsupported length L_f

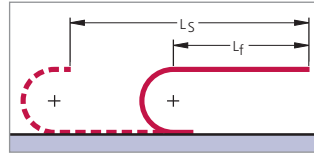

Determining the length of the cable carrier see page 38.

Inside heights



Chain widths



kabelschlepp.de

Font: +49 2762 4003-0

OnlineEngineer.de
Kabelschlepp
Cable Carrier Configurator



Design and ordering

Please contact us, we would be happy to advise you.

Steel band covers



Cable carriers made of rust and acid resistant spring steel strip can be supplied for protection of the cables against flying sparks, radiant heat and small chips.

- Economically priced cover variant for half-stay version
- Made of rust and acid resistant spring band steel
- Maximum steel band width: 1000 mm

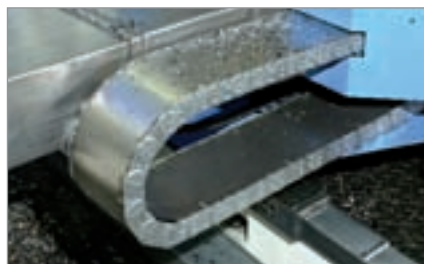

kabelschlepp.de

Table of dimensions

Type	Steel band length		Steel band width
	Outside steel band	Inside steel band	
S/SX 0650	$L_k + 280$	$L_k + 130$	$B_k - 22$
S/SX 0950	$L_k + 360$	$L_k + 150$	$B_k - 27$
S/SX 1250	$L_k + 470$	$L_k + 170$	$B_k - 34$
S/SX 1800	$L_k + 640$	$L_k + 200$	$B_k - 40$
S/SX 2500	$L_k + 945$	$L_k + 255$	$B_k - 48$

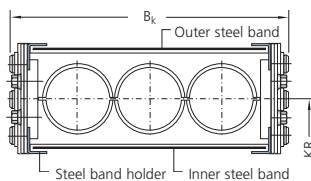

Steel band covers for the other series are available on request!

Dimensions in mm

Fon: +49 2762 4003-0

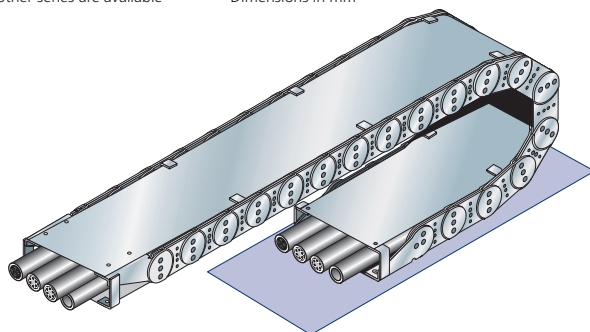

Fastening the steel band



■ Steel band holder on the sidebands.

■ Fastening to the chain connection with special end connector.

Use our free project planning service.

Support rollers – horizontal arrangement "with support"

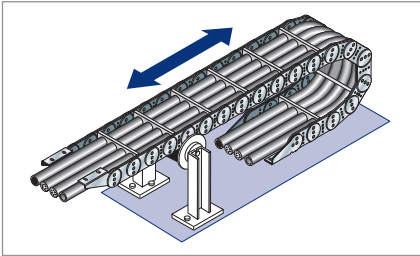

- If the unsupported length of the cable carrier is exceeded, the upper trough can be supported by rollers.
- Instead of using a KABELSCHLEPP cable carrier with supports, we recommend that you use the next size up, provided that the installation conditions allow this.

Arrangement of the support

Arrangement with a support roller:

when $L_S < 3 L_f$ $a_R = \frac{L_S}{6}$

The distance of the support to the fixed point in this arrangement is approx 1/6 of the total travel length!

Schematic illustration

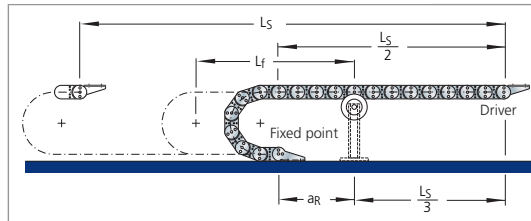

Standard support rollers

for Types LS/LSX 1050, S/SX 0650, 0950, 1250, 1800

- Economically priced standard support rollers in light-weight design
- Long service life due to ball-bearing rollers
- Optimized installation width
- Only for use with two-band chains

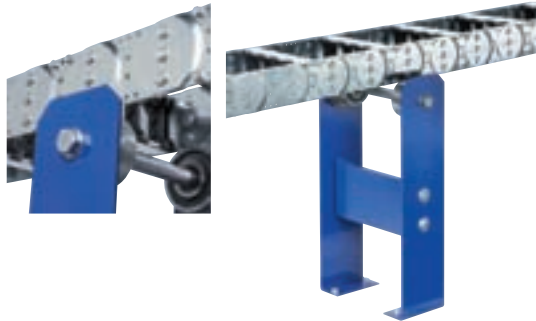

Support rollers with reinforced design

for Types LS/LSX 1050, S/SX 0650, 0950, 1250 and 1800

- Solid design for extreme loads
- Long service life due to ball-bearing roller
- Also suitable for multi-band chains
- With hard manganese wear protection for type S/SX and applications with high loads
- Also available in stainless steel version

